

Hauptstromkreis Aussengerät / Hydroeinheit, 3 kW Stützheizung

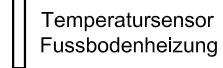
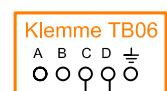
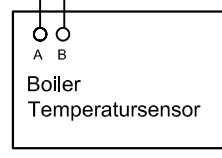
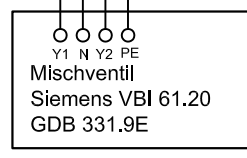
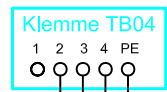
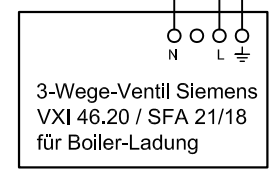
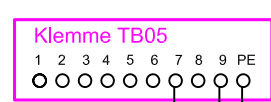
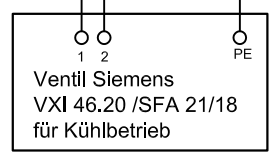
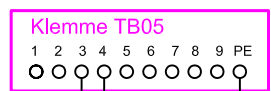
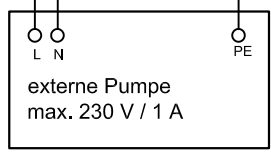
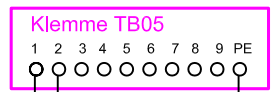
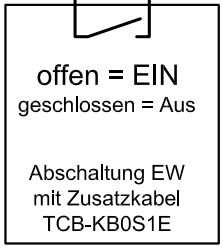
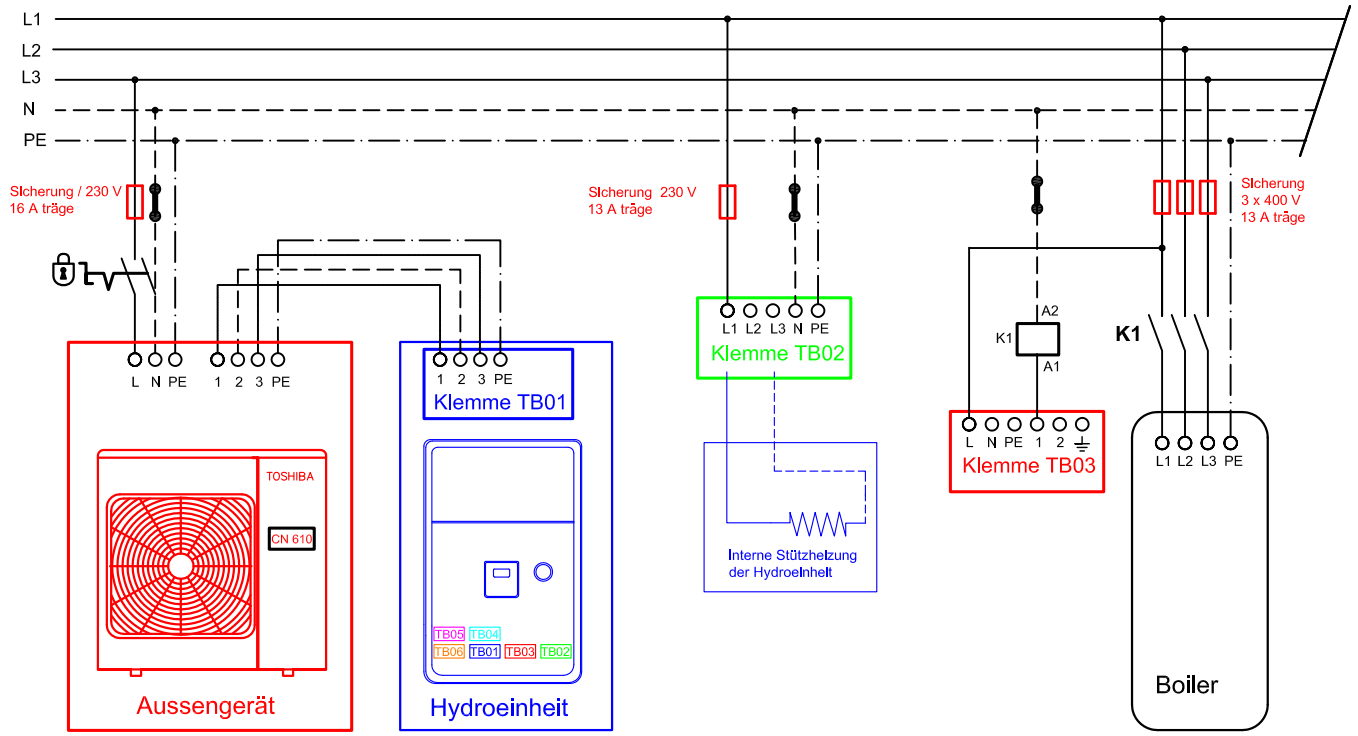

TOSHIBA Estia Wärmepumpe Hauptstromkreis	MstL: - :- Datum: 5.12.2011
Krüger + Co. AG 9113 Degersheim Tel. 071/372 82 82	gez: ak 230V-Gebrauchsanleitung